



PROFESSIONAL DISHWASHER

EN



CONTENTS

1	PRECAUTIONS FOR SAFETY AND USE	3
2	TECHNICAL DATA	5
3	INSTALLATION AND POSITIONING.....	7
4	INSTRUCTIONS FOR TECHNICAL STAFF.....	8
4.1	Plumbing hookup.....	8
4.2	Electrical connection.....	9
5	FIRST START-UP.....	11
5.1	Rinse aid dispensing setting (on models with diaphragm pump with manual setting only).....	12
5.2	Using the water softener (on models with this feature only).....	13
6	SET-UP	14
6.1	Dishwasher parameter modification procedure:	14
6.2	Quit “ SET-UP “ menu.....	16
6.3	Rinsing temperature setup	16
6.4	Washing temperature setup	16
6.5	Detergent dispensing setup (if featured)	17
6.6	Rinse aid dispensing setup (if featured)	17
6.7	Autostart function	17
6.8	Regeneration frequency setup (models with softener).....	18
6.9	tStP (minimum rinsing temperature) function.....	18
6.10	Rinse aid pump (display and if required reset during maintenance) (if featured) 19	
6.11	Detergent pump (display and if required reset during maintenance) (if featured) 19	
6.12	Energy consumption – Display and reset if required.....	19
6.13	Service setting (for After-Sales Service only).....	19

- 6.14 Starting the peristaltic pumps – rapid filling of detergent and rinse aid delivery circuit.(if featured) 19
- 7 MALFUNCTIONS SHOWN ON THE DISPLAY (FOR THE TECHNICIAN) 20
- 8 INSTRUCTIONS FOR THE USER 22
 - 8.1 Control panel 22
 - 8.2 Before washing 22
 - 8.3 First use each day (tank and boiler empty) 23
 - 8.4 Changing the Program 24
- 9 CHOOSING THE PROGRAM 25
- 10 *SUPPLEMENTARY FUNCTIONS* 26
 - 10.1 Selecting the crys“glassware” function (available in P1-P2)..... 26
 - 10.2 Selecting the “extra rinse” function (available in P1-P2-P3-P4)..... 26
 - 10.3 Selecting the “sanitisation” function (only available in P3) 27
- 11 MAINTENANCE AND CLEANING 29
 - 11.1 Daily cleaning..... 29
 - 11.2 Routine inspection of the spray arms 30
 - 11.3 Lengthy periods out of use 30
- 12 TROUBLESHOOTING..... 31
- 13 MALFUNCTIONS SHOWN ON THE DISPLAY (FOR THE USER) 33

SMEG thanks you for choosing one of its products.

Read all the instructions in this manual carefully to become familiar with the right conditions for the proper use of your dishwasher.

TECHNICAL INSTRUCTIONS

	<p>These are intended for the qualified staff who are to install, commission and test the appliance and carry out any servicing and repairs.</p>
--	--

INSTRUCTIONS FOR THE USER

	<p>These provide recommendations for use, a description of the controls and the correct procedures for cleaning and maintaining the dishwasher.</p>
--	---

1 PRECAUTIONS FOR SAFETY AND USE

	<p>THIS MANUAL IS AN INTEGRAL PART OF THE DISHWASHER AND MUST ALWAYS BE KEPT INTACT TOGETHER WITH THE APPLIANCE.</p>
	<p>POSITIONING, HOOKUP, COMMISSIONING, TROUBLESHOOTING AND REPLACING THE POWER CABLE MUST ALWAYS BE CARRIED OUT BY QUALIFIED STAFF.</p>
	<p>THE APPLIANCE MUST BE GROUNDED AS REQUIRED BY ELECTRICAL EQUIPMENT SAFETY STANDARDS.</p>





THE DISHWASHER IS INTENDED FOR PROFESSIONAL USE ONLY AND MUST ONLY BE USED BY AUTHORISED STAFF. IT IS DESIGNED TO WASH TABLEWARE (PLATES, CUPS, BOWLS, OVEN DISHES AND CUTLERY) AND SIMILAR ITEMS IN THE RESTAURANT AND INSTITUTIONAL CATERING SECTOR, AND COMPLIES WITH THE INTERNATIONAL STANDARDS ON ELECTRICAL AND MECHANICAL SAFETY (CEI-EN-IEC 60335-2-58/61770) AND ELECTROMAGNETIC COMPATIBILITY (CEI-IEC-EN 55014-1/-2, 61000-3;4, 50366).

THE MANUFACTURER **DECLINES ALL RESPONSIBILITY FOR INJURY OR DAMAGE CAUSED BY FAILURE TO COMPLY WITH THE INSTRUCTIONS IN THE MANUAL, BY INCORRECT USE, BY TAMPERING WITH EVEN JUST ONE PART OF THE APPLIANCE AND BY THE USE OF NON-ORIGINAL SPARE PARTS .**

THIS APPLIANCE IS TAGGED UNDER EUROPEAN DIRECTIVE **2002/96/EC** ON WASTE ELECTRICAL AND ELECTRONIC EQUIPMENT (WEE).
 BY MAKING SURE THAT THIS PRODUCT IS DISPOSED OF CORRECTLY THE USER HELPS TO PREVENT POTENTIAL DETRIMENTAL EFFECTS ON HEALTH AND THE ENVIRONMENT.

WHEN DECOMMISSIONING THE APPLIANCE COMPLY WITH THE LOCAL WASTE DISPOSAL REGULATIONS.

FOR FURTHER INFORMATION ON THE TREATMENT, RECOVERY AND RECYCLING OF THIS PRODUCT, CONTACT THE COMPETENT LOCAL OFFICE, THE DOMESTIC WASTE COLLECTION SERVICE, OR THE SHOP WHERE THE PRODUCT WAS PURCHASED.

	<p>THE SYMBOL OF THE RUBBISH BIN WITH A BAR ACROSS IT ON THE PRODUCT OR IN THE TECHNICAL DOCUMENTATION INDICATES THAT THIS PRODUCT MUST NOT BE TREATED AS ORDINARY DOMESTIC WASTE BUT MUST BE CONSIGNED TO THE SPECIAL COLLECTION POINT FOR THE RECYCLING OF ELECTRICAL AND ELECTRONIC EQUIPMENT.</p>
	<p>NEVER PLACE SOLVENTS SUCH AS ALCOHOL OR TURPENTINE, WHICH MIGHT CAUSE AN EXPLOSION, INSIDE THE APPLIANCE. NEVER LOAD DISHES DIRTY WITH ASH, WAX OR PAINTS.</p>
	<p>NEVER USE THE DISHWASHER OR ANY PART OF IT AS A LADDER, SUPPORT OR STAND FOR PEOPLE, ANIMALS OR ANY OBJECT. LEANING OR SITTING ON THE OPEN DOOR OF THE DISHWASHER MIGHT CAUSE IT TO TIP OVER, PUTTING PEOPLE IN DANGER. NEVER LEAVE THE DISHWASHER DOOR OPEN SINCE PEOPLE MIGHT TRIP OVER IT.</p>
	<p>DO NOT DRINK ANY WATER LEFT IN THE DISHES OR DISHWASHER AT THE END OF THE WASHING PROGRAM.</p>
	<p>THE APPLIANCE IS NOT SUITABLE FOR USE BY JUVENILES OR PERSONS WITH REDUCED PHYSICAL, SENSORIAL OR MENTAL CAPACITIES, OR THOSE WITHOUT THE NECESSARY KNOWLEDGE AND EXPERIENCE. SUCH PERSONS MAY ONLY USE THE APPLIANCE UNDER THE SUPERVISION OF A PERSON RESPONSIBLE FOR THEIR SAFETY.</p>

2 TECHNICAL DATA

Supply voltage	V	400V 3N ~
Convertible to single-phase version	V	230V 1N ~
Frequency	Hz	50
Max. power absorption at 400V 3N ~ (3 branches of heating element)	kW	4.8
Max. power absorption at 230V 1N ~ (2 branches of heating element)	kW	3.3
Max. power absorption at 230V 1N ~ (1 branch of heating element)	kW	1.8
Boiler heating element power at 400V 3N ~ (3 branches of heating element)	kW	4.5
Boiler heating element power at 230V 1N ~ (1 branch of heating element)	kW	1.5
Tank heating element power	kW	0.8
Water intake pressure	kPa (bar)	100-600 (1 ÷ 6)
Water intake temperature	°C	15°C – 60°C
Water hardness (on models with softener <60°f)	°f	<15°f
Rinse cycle water consumption	l	2.3
Boiler capacity	l	4
Tank capacity	l	7
Durée cycle standard avec alimentation d'eau à 50°C	s	90/150/240
Noise level	dB(A)	< 60
Degree of protection	IPX	4
Net weight	Kg	44/48
Power supply cable type	◀HAR▶	H07RN-F
Fuse	A	4

	400V 3N ~		230V 1N ~		C = Power Supply Cable S = master switch
	C	S	C	S	
1.8kW	----	----	3X2.5	16° 3P+N	
3.3kW	----	----	3X2.5	16° 3P+N	
4.8kW	5x2.5	16° 3P+N			

CAVITY DIMENSIONS FOR BUILT-UNDER INSTALLATION

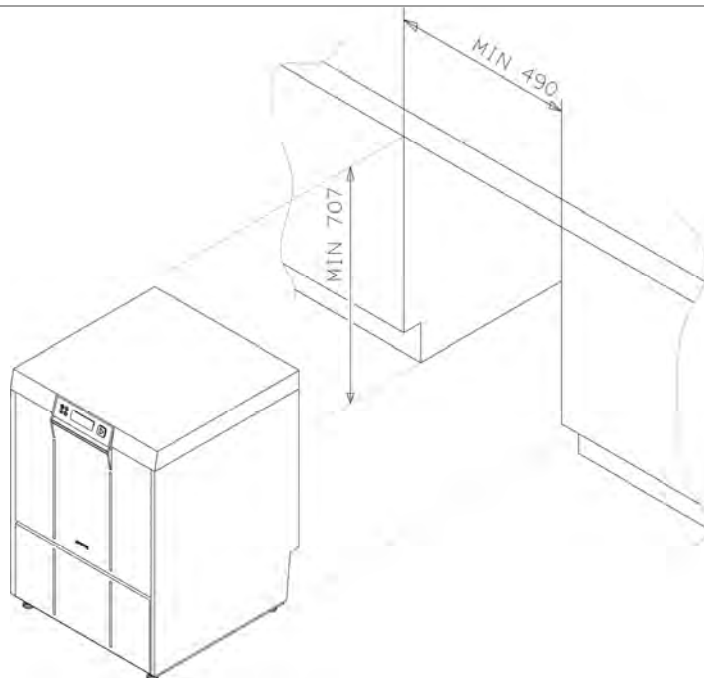

APPLIANCE DIMENSIONS AND CONNECTION POSITIONS

(**N.B. – VALUE “1000” WITH ASTERISK: max 600 if siphon with valve is used)

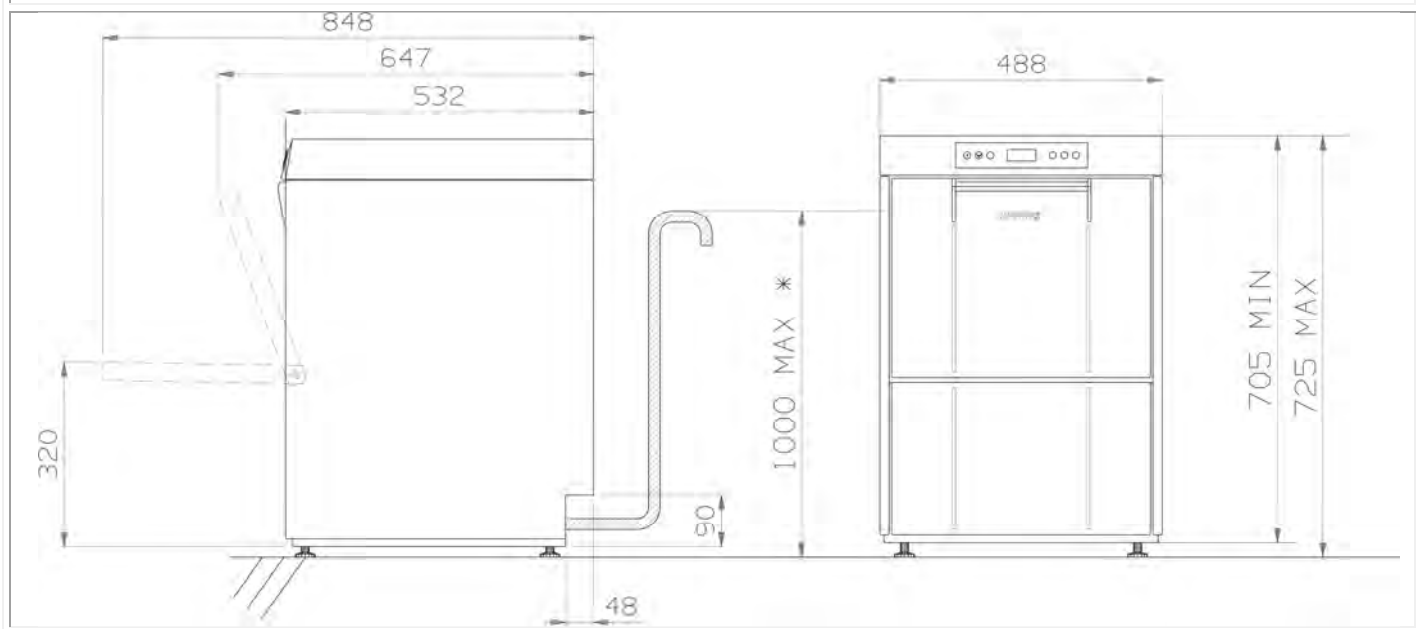

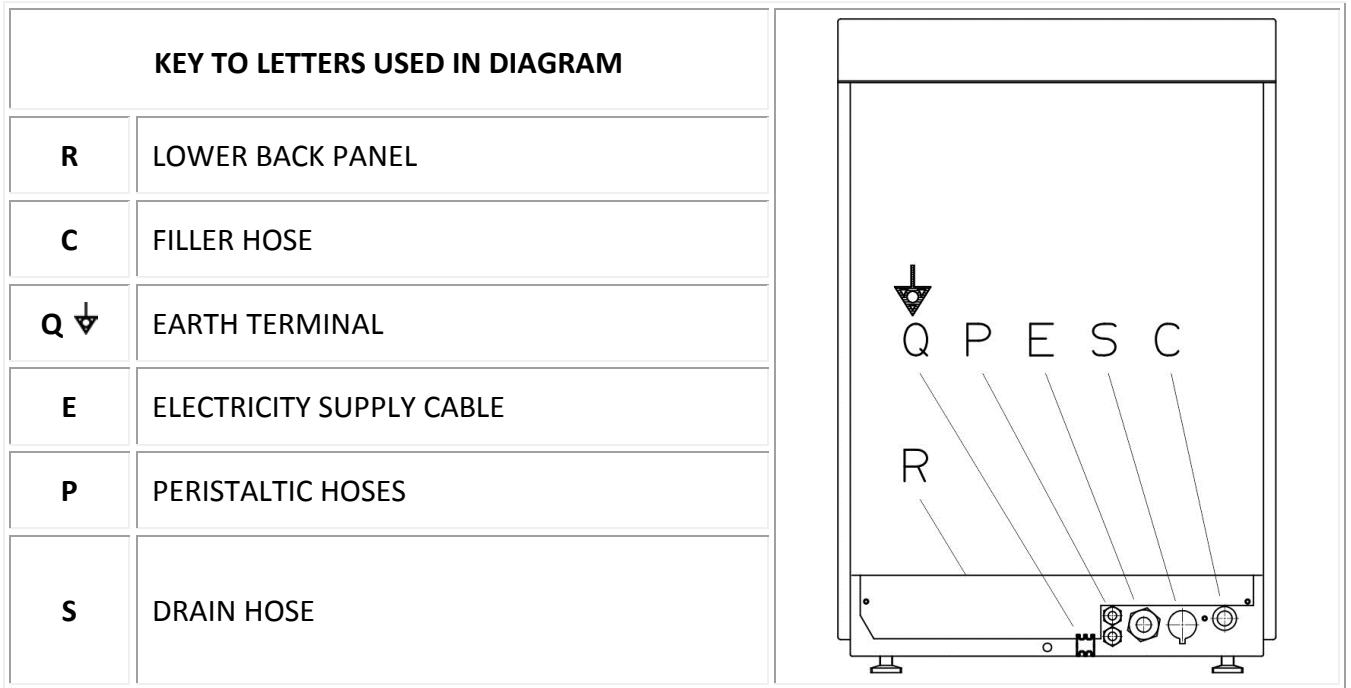

3 INSTALLATION AND POSITIONING

INSTALLATION and POSITIONING

Bring the dishwasher to the installation site, remove the packaging and check the appliance and components for damage; any damage found must be reported to the transporter in writing.

The packaging components (plastic bags, expanded polystyrene, nails, etc.) must not be left within reach of children and pets since they are potentially dangerous. All packaging materials used are environment-friendly. They can be kept without constituting any hazard, or may be disposed of at a specialist waste disposal centre. The plastic components suitable for recycling are marked as follows: PE polyethylene: external packaging film, bag containing the instructions, protective bags. PP polypropylene: straps. PS expanded polystyrene: corner guards, top of packaging. Wooden and cardboard components can be disposed of in accordance with the relevant regulations. When the product is decommissioned it must not be dumped in the environment; it must be disposed of in accordance with the relevant regulations. All metal parts are in stainless steel and can be removed. The plastic parts are marked with the symbol identifying the material used and may be disposed of in accordance with the relevant regulations. When the product is decommissioned it must not be dumped in the environment; it must be disposed of in accordance with the relevant regulations. All metal parts are in stainless steel and can be removed. The plastic parts are marked with the symbol identifying the material used.

POSITIONING:



Caution: the indoor system and premises in which equipment for institutions is installed must comply with the relevant regulations.

The manufacturer declines all liability for direct or indirect injury or damage deriving from failure to comply with these regulations.

Before installation, check that there are no objects or materials in the vicinity which may be damaged by steam or splashes of washing solution, or that any such items are suitably protected.

Place the dishwasher in the chosen point and remove the protective film.

Level the dishwasher (with the aid of a spirit level) on its adjustable feet to ensure that it is stable; all other mounting solutions must be approved by the manufacturer.

4 INSTRUCTIONS FOR TECHNICAL STAFF

4.1 Plumbing hookup



Water supply and drain hookup

The water pipelines and electricity supply cable lead out of the bottom right-hand corner of the appliance. Connect the water intake hose to a connector with $\frac{3}{4}$ " **gas** threaded fitting, fitting the filter **A** provided (in models with aquastop, the filter and ring-nut form a single unit).

The connection to the water mains must only be made with new hoses; the use of old or worn hoses is not permitted.

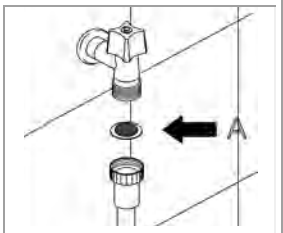

The **dynamic** water supply **pressure must** be between **1 and 6 bar**; if it is higher, installation of a pressure reducer is necessary.

It is essential to fit a main stop tap on the water intake deliver pipeline; the tap must be accessible after installation of the appliance, so do not install it behind the dishwasher. The stated cycle duration applies to appliances supplied with **hot water >50°C<60°C**. If the dishwasher is supplied with cold water, the cycle duration might increase depending on the intake water temperature. The dishwasher **is fitted with a drain pump** and can operate with drain connections on the floor or wall.

Refer to the connection diagram for the maximum permitted height of wall drains – (see TECHNICAL DATA)



Caution: make sure that the intake and drain hoses are not bent, constricted or crushed after installation.

When installing the drain hose to a siphon with valve, the maximum height of the drain outlet is reduced to 600 mm.

4.2 Electrical connection





	<p>The dishwasher and any additional equipment must be connected to the electrical system by authorised, skilled staff, in accordance with the relevant regulations; also comply with the technical instructions for the connection.</p> <p>The total rated power is stated on the appliance's technical data plate.</p> <p>The electrical protection devices fitted for the dishwasher must serve this appliance only.</p> <p>The user must have a master switch and a differential safety breaker, with rating suitable for the appliance's characteristics, installed on the electricity supply line in accordance with the relevant regulations.</p> <p>These switches must be installed close to the dishwasher, be easily accessible after installation, and provide complete disconnection from the electrical mains in overvoltage class III conditions.</p>
	<p>Warning !!! The dishwasher is always powered up unless the master switch is turned off.</p>
	<p>Connect the appliance to the user's earth system. The  terminal for the connection is in the bottom right-hand corner of the appliance.</p> <p>The earth wire (PE) is yellow-green in colour, the neutral wire (N) is blue and the live wires (L1, L2, L3) are black, grey and brown.</p> <p>In the event of single-phase connection (230V-1N~), the connection to the electrical mains must be made using a cable with plug compliant with the relevant regulations.</p>
	<p>THE POWER SUPPLY CABLE MUST BE REPLACED BY THE MANUFACTURER OR AN AUTHORISED SERVICE CENTRE TO PREVENT ALL RISKS.</p>

Figure 1 – Appliance electrical system diagram



5 FIRST START-UP

First start-up

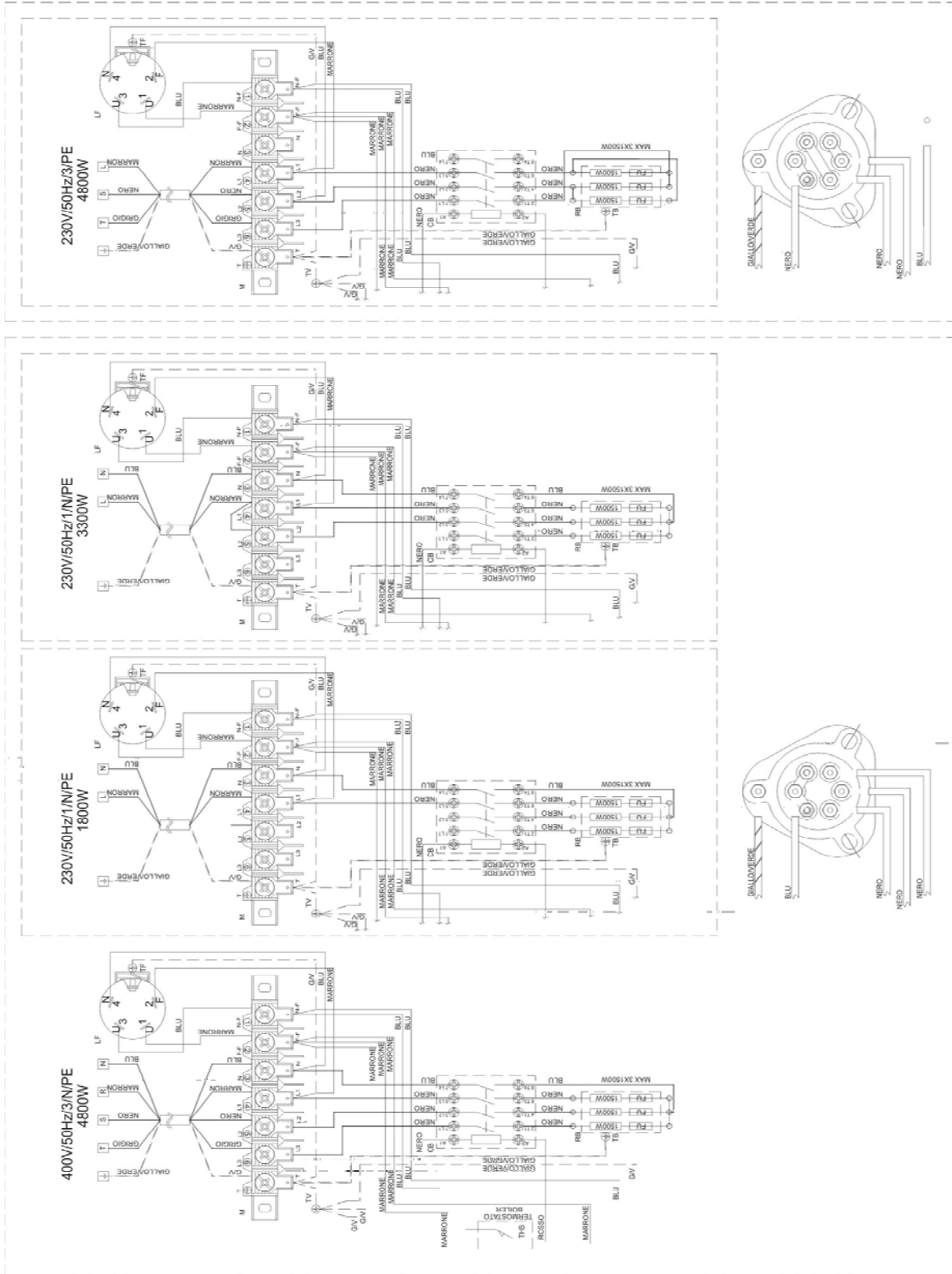
The electrical protection system must undergo a functional test before the appliance is put into operation.

The appliance must be installed and/or inspected by qualified staff, who will start it up for the first time and provide the relevant operating instructions.

Preparing for use (important)

The rinse aid dispenser is fitted on all models, the detergent dispenser only on some.

If both dispensers are present put the external detergent and rinse aid containers in place and insert the respective intake hoses on the rear of the appliance into them.

Red hose: detergent

blue hose: rinse aid

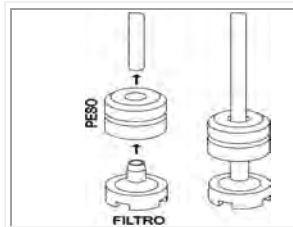

Before inserting the hoses into the containers, fit the weights (needed to ensure that they always draw in liquid from the bottoms of the containers) and the filters onto their ends as shown.

If the detergent dispenser is not factory-fitted, it can be retrofitted by ordering the relative kit.

As an alternative an external dispenser can be fitted, making the electrical connection by means of an H05 RN-F 2x0.5 mm electrical cable, which can be laid along the route shown in the TECHNICAL DATA diagram and connected as shown in the wiring diagram supplied with the dishwasher.

The dispenser must operate on 230V/50 Hz with maximum power absorption of **15 W**.

Connect to the detergent dispenser outside the dishwasher using the red hose mentioned above.

5.1 Rinse aid dispensing setting (on models with diaphragm pump with manual setting only)

Note: If peristaltic rinse aid pump is installed see point 6.6

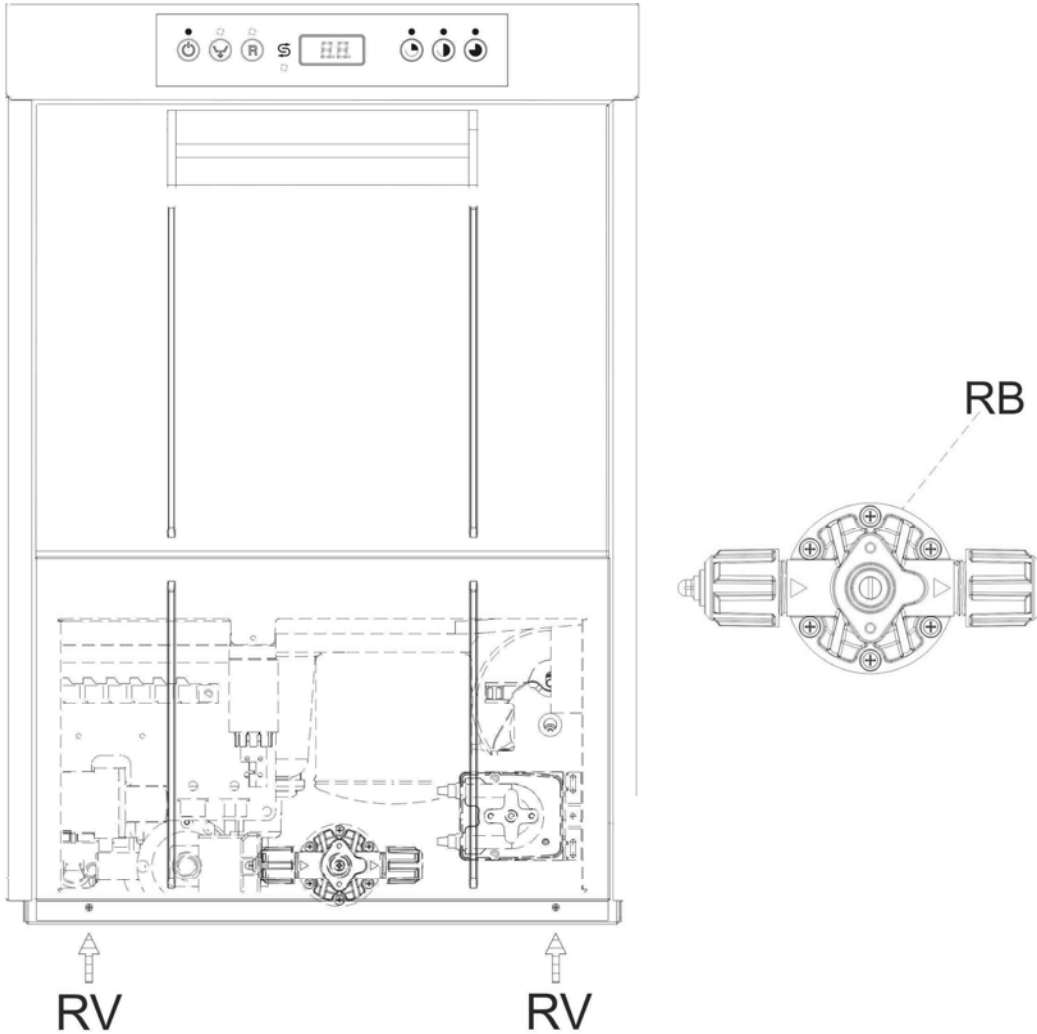

RB	Rinse aid dispensing regulator screw
RV	Inspection panel removal screw

RB: Rinse aid dispensing regulator screw
Adjustments are made using the adjuster screw AS SHOWN. The **quantity** dispensed is **reduced** by turning **clockwise** and **increased** by turning **anticlockwise**.

5.2 Using the water softener (on models with this feature only)



The quantity of lime in the water (which indicates its hardness) causes whitish marks on dry dishes and dishes also tend to lose their shine over time. The dishwasher is equipped with an automatic water softener which removes the substances that cause hardness from the water with the aid of regenerating salt.



The first time the dishwasher is used, a litre of water must be poured into the tank with the salt. Whenever the tank is filled, always take care to ensure that the cap is firmly closed. The mixture of water and detergent must not get into the salt tank, as this would impair operation of the regeneration system. In this case warranty cover will be forfeited.



Whenever the type of detergent or rinse aid is changed, it is ABSOLUTELY ESSENTIAL to flush out the peristaltic pumps by placing the external intake pipes in water for a few cycles.

Always use only products **specifically recommended** for use in a dishwasher.

Failure to comply with this recommendation leads to **forfeiture of the warranty entitlement** on the appliance's water system.

The **internal pipes of the detergent and rinse aid pumps** should be replaced by the After-Sales Service **every 12 months or 15,000 wash cycles** and operation of the diaphragm can be disposed of in accordance with the relevant regulations. The **rinse aid pump** should be checked.

6 SET-UP



Set-up

During first start-up, the functions/parameters listed below must be set or adjusted:

6.1 Dishwasher parameter modification procedure:

Indicator lights showing: ○ off; ⊙ green; ⊖ orange; ⚙ flashing.

Access “programming mode” by pressing the button for a few seconds with the appliance on with the door open and the tank empty. The display shows UnLo1:58; when the beep sounds, release the button and press it again at once. Keep pressing the button again to scroll through all the modifiable parameters in the following order:

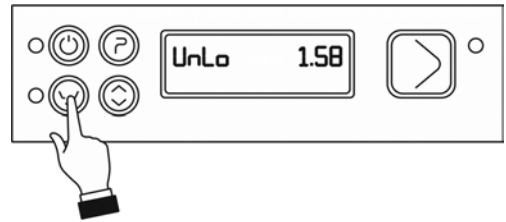

Rinsing temperature (boiler temperature)

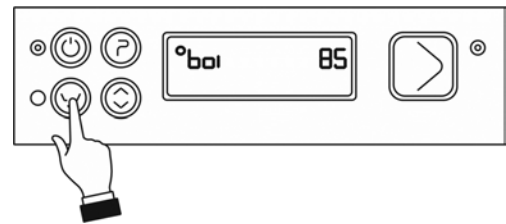

Washing temperature (tank temperature)

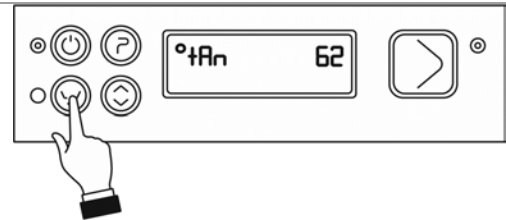

Quantity of detergent dispensed (if featured), the number indicates the seconds of peristaltic pump operation)

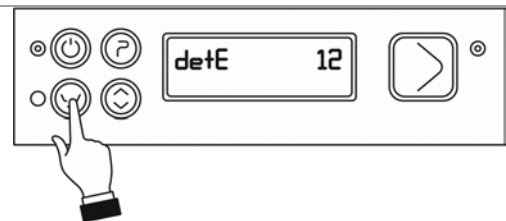

Quantity of rinse aid dispensed (if featured), the number indicates the seconds of peristaltic pump operation)

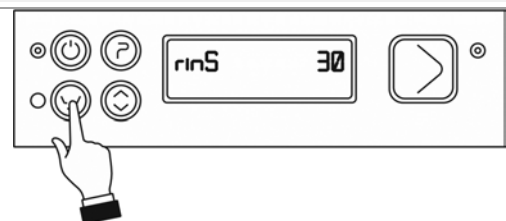

Start-on/start-off

Set at “on” to start the cycle when the door is closed.
Set at “off” for cycle start after confirmation with the start button

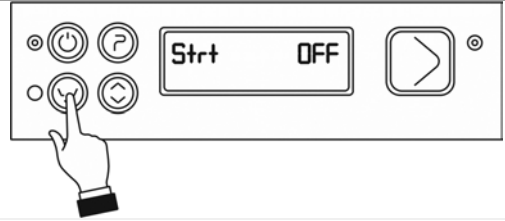

Water hardness setting (if featured), on models with softener only

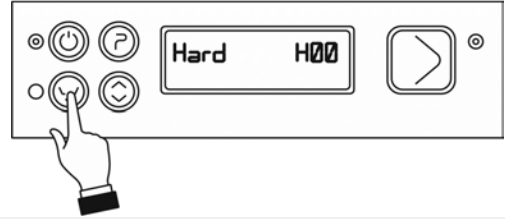

tStP on/off “on” = **minimum rinsing temperature** as set, regardless of intake water temperature.
If the intake water is not hot; the cycle duration might be a few seconds longer than the nominal timing, “off” = the **minimum rinsing temperature** might be a few degrees lower than the setting

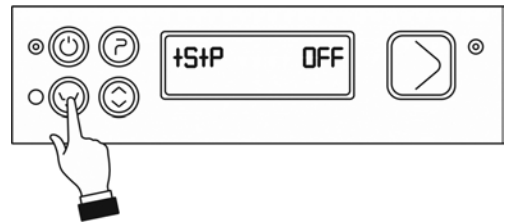

Rinse aid pump total operating minutes display. (if featured)
This value can be reset during pump maintenance - see below.

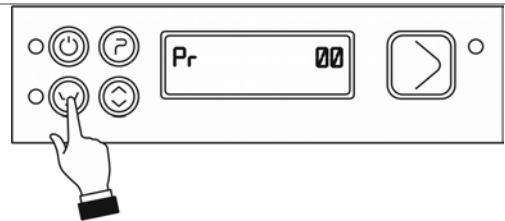

Detergent pump total operating minutes display. (if featured)
This value can be reset during pump maintenance - see below.

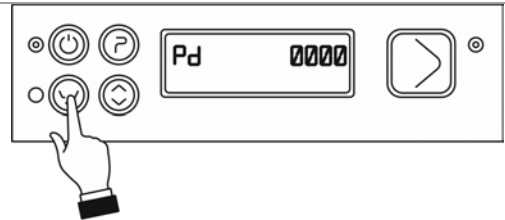

Energy consumption (kW) display
The **Pc** option indicates the total kW consumed since installation of the dishwasher or since the latest reset.

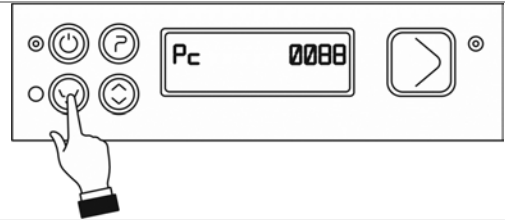

Display of the number of cycles performed
When scrolling through the appliance parameters, the “tc 88888” item will also appear; this is the count of the total cycles performed by the dishwasher since installation.
This parameter cannot be modified or reset unless the software is reprogrammed.

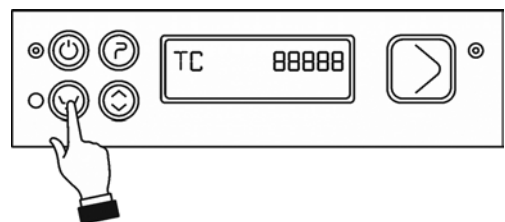

This submenu and the relative functions can only be accessed with the aid of a password available on SmegTech and only by technical staff.

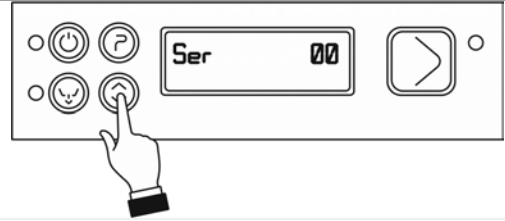

6.2 Quit "SET-UP" menu

Wait more than 10 seconds without pressing any button and the appliance quits this menu automatically,
or press the on/off button to exit.

Indicator lights showing: off; green; orange; flashing.

Caution: the tank and boiler temperatures shown on the display may differ from the actual temperatures by a few degrees, especially in transient phases (just after the FILL is completed, just after the end of the cycle, etc.) due to the inertia of the measurement probe.

6.3 Rinsing temperature setup

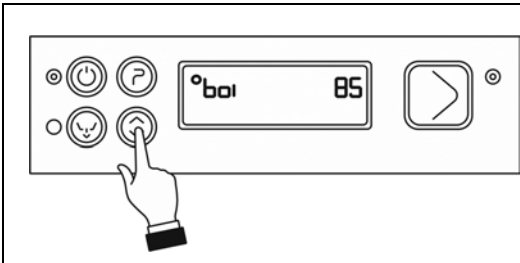

Modify the value of the parameter by pressing .
(Default value: 85°C)
Min. 71°C – max. 85°C

6.4 Washing temperature setup

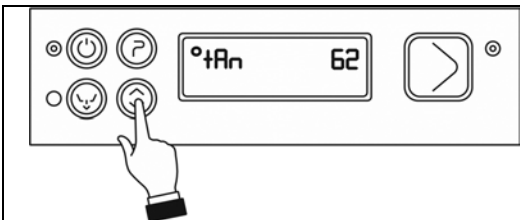

Modify the value of the parameter by pressing .
(Default value: 62 °C)
Min. 52°C – max. 62°C

Indicator lights showing: off; green; orange; flashing.

6.5 Detergent dispensing setup (if featured)

Modify the value of the parameter by pressing

DETERGENT	
Delivery time (s)	Delivery quantity (c.c.)
0	0.0
2	0.8
4	1.7
6	2.5
8*	3.3
10	4.2
12	5.0
14	5.8
16	6.7
18	7.5
20	8.3

* default value (factory preset)

6.6 Rinse aid dispensing setup (if featured)

Modify the value of the parameter by pressing .

RINSE AID	
Delivery time (s)	Delivery quantity (c.c.)
0	0,0
6	0.7
12	1.3
18	2.0
24	2.7
30*	3.3
36	4.0
42	4.7

* default value (factory preset)

6.7 Autostart function

Modify the parameter (ON/OFF) by pressing .

Set at "on" to start the cycle when the door is closed.

Set at "off" for cycle start after confirmation with the start button

6.8 Regeneration frequency setup (models with softener)

- (Default value: **H03**; modify the parameter to suit the mains water hardness.
- At first use, the salt tank has to be filled. It is subsequently sufficient simply to fill up with regenerating salt when necessary.

	Modify the value of the parameter by pressing .	Hardness (°d German degrees) Regeneration off	Hardness (°f French degrees) Regeneration off	Setting level H00
		8.5	15	H01
		11	20	H02
		17	30	H03
		22.5	40	H04
		28	50	H05
		33.5	60	H06
		Regeneration cycle duration: 12 minutes		

With values over 60°F an external water treatment device must be used and the regeneration frequency **must be set on H00**.

6.9 tStP (minimum rinsing temperature) function

	Modify the parameter (ON/OFF) by pressing .
--	---

Set at “on” for minimum rinsing temperature as set; set at “off” for rinsing regardless of boiler temperature.

If the parameter is set as “off” and hot intake water is not used, the minimum rinsing temperature might be a few degrees lower than the setting.

If the termostop device is set “off” the rinsing is no longer monitored and the user is responsible for ensuring that the minimum correct T° are maintained for the tank and boiler. It is particularly important to check the intake water temperature. Also refer to the insufficient washing/drying / foam in tank point of the “troubleshooting” section: restore T Stop ON and/or connect the appliance to a hot water supply

6.10 Rinse aid pump (display and if required reset during maintenance) (if featured)

	<p>To reset, press for 3 seconds.</p>
--	--

6.11 Detergent pump (display and if required reset during maintenance) (if featured)

	<p>To reset, press for 3 seconds.</p>
--	--

6.12 Energy consumption – Display and reset if required

	<p>To reset, press for 3 seconds.</p>
--	--

6.13 Service setting (for After-Sales Service only)

	<p>See information on Smegtech</p>
--	------------------------------------

6.14 Starting the peristaltic pumps – rapid filling of detergent and rinse aid delivery circuit. (if featured)

Perform after the parameter modification procedure explained in the previous point.

Indicator lights showing: ○ off; ⊙ green; ◌ orange; ⚡ flashing.

<p>With the dishwasher powered up, access “programming mode” by pressing the on/off button for a few seconds; at the “beep”, release the button and press it again quickly within 0.5 seconds. The peristaltic pumps continue to operate until the same button is pressed again. The rinse aid and detergent symbol</p>	
---	--

lights remain on as long as the pumps are on; bear in mind that the rinse aid peristaltic pump fills the circuit in about 7 minutes, while for the detergent it only takes 2 minutes. So draw only rinse aid from the jerry cans (1 for the rinse aid and the other for the detergent) for the first 5 minutes and then also take in detergent for the last 2.

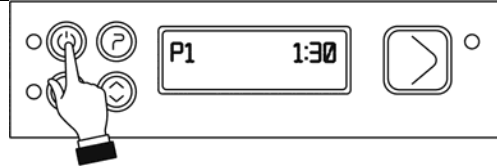

7 MALFUNCTIONS SHOWN ON THE DISPLAY (FOR THE TECHNICIAN)

The dishwasher is able to identify a number of malfunctions and show them on the display. If the problem persists after the dishwasher has been switched off and back on, proceed as described below:

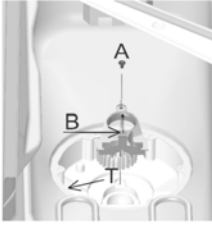
Err04	Tank temperature probe malfunction	Tank temperature probe disconnected or not working.
Err05	Tank water filling malfunction	<p>The tank does not fill within the allowed time: check water intake tap, dynamic pressure in intake system, cleaning of water intake filter, possible damage to water intake hose or cleaning of rinsing nozzles.</p> <p>If the problem persists during FILL:</p> <ul style="list-style-type: none"> - tank pressure switch has failed (continuous empty reading: check whether tank safety pressure switch is tripped) - leak from pipe connected to air trap <p>If the problem occurs during work cycle</p> <ul style="list-style-type: none"> - filler hose bleeder valve fouled: tank empties completely at end of a wash cycle due to siphon effect.
Err06	<p>Water pump-out malfunction</p> 	<p>Inspect the filters for dirt and check that the drain hose is not blocked, bent or crushed.</p> <p>Check that the drain pump is not blocked by dirt by removing the insert on the sump (from inside the tank).</p> <p>If it persists, check in this order:</p> <ul style="list-style-type: none"> - with tank empty: constant “tank full” signal: tank pressure switch faulty or leak from connections of air trap connection pipe (water entering pipe) - with tank full: drain pump failure
Err09	Too much water in tank	<p>With tank full: see above (water pump-out malfunction)</p> <p>With tank empty: constant “tank full” signal: safety pressure switch faulty or leak from connections of air trap connection pipe (water entering pipe)</p>

<p>Err23</p>	<p>Boiler does not heat up as expected</p>	<p>The problem might occur because water is continually entering the tank (the causes are as for Err5 – see above) If it persists, check in this order: - damaged boiler heating element - contactor failure, - boiler safety thermostat failure, - boiler temperature probe faulty or incorrectly positioned - motherboard relay failure, Important: if the boiler heating element is damaged, this might be due to operation with no water in the boiler - the pressure switch is indicating full even with the boiler empty: check and if necessary replace the boiler air trap and/or the relative pressure switch: the problem is generally preceded by “boiler overheating E28”</p>
<p>Err24</p>	<p>Boiler temperature probe malfunction</p>	<p>boiler temperature probe disconnected or not working</p>
<p>Err25</p>	<p>Boiler water filling malfunction</p>	<p>The boiler does not fill within the allowed time: check water intake tap, dynamic pressure in intake system, cleaning of water intake filter, possible damage to water intake hose Or check in this order: - boiler pressure switch has failed (continuous empty reading) - pipe leaking/disconnected (water entering pipe)</p>
<p>Err26</p>	<p>Boiler emptying malfunction</p>	<p>- check that rinsing spray arm nozzles are clean - boiler pressure switch has failed (continuous full reading) - pipe leaking/disconnected (water entering pipe) - rinsing pump not working</p>
<p>Err27</p>	<p>Boiler emptying malfunction – with tank full</p>	<p>Boiler pressure switch has failed (continuous full reading)</p>
<p>Err28</p>	<p>Boiler heating malfunction (overheating)</p>	<p>First check: - boiler pressure switch has failed (continuous full reading) - pipe leaking/disconnected: water entering pipe connected to air trap, pressure switch continues to give full reading even with boiler empty, heating element operating dry. Or: - circuit board relay failure, or - contactor failure</p>

8 INSTRUCTIONS FOR THE USER

8.1 Control panel

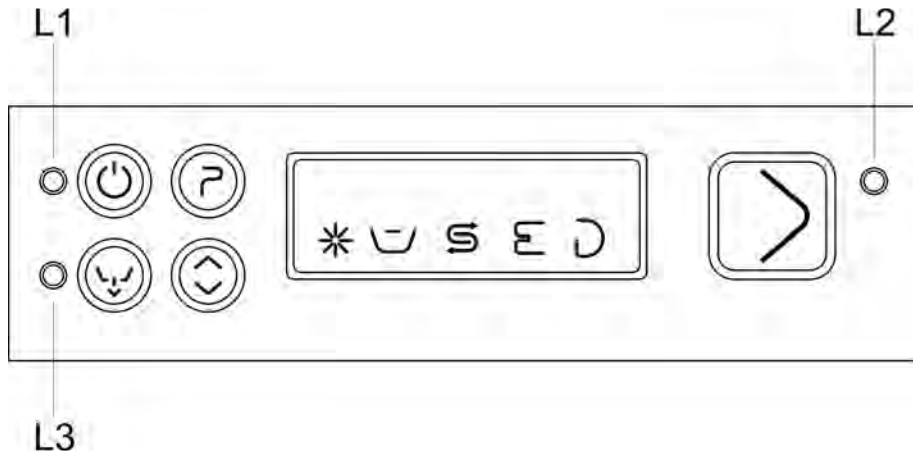

	On-off button
	Program selection button
	Start CONFIRM/PAUSE button
	Total emptying button (tank and boiler)
	Additional function selection button
	L1 Mains power on light
	L2 Intake/standby cycle in progress light (red/green)
	L3 Pump-out in progress light
	No rinse-aid symbol (if a system for monitoring outside the dishwasher is provided)
	Tank heating element on symbol
	No salt symbol (if softener is fitted)
	Boiler element on symbol
	No detergent symbol (if a system for monitoring outside the dishwasher is provided)

8.2 Before washing

Use only detergents and rinse aids for industrial dishwashers.

Do not use detergents intended for hand washing.

We recommend the use of Smeg products, specially developed for this dishwasher.



When topping up the tanks, take care not to swap the products; this might damage the dishwasher and cause malfunctions.

Do not mix different detergents; this would damage the dispenser device.

Industrial dishwasher detergents may cause serious irritation. Comply carefully with the instructions provided by the detergent producer on the pack.

Turn on the mains water tap (user)	Check:			Switch on the master switch (user): the word "OFF" appears on the display.
	The level of detergent and rinse aid in the containers.	That there is regenerating salt in the relative container (if fitted).	That the filters are in place, the spray arms rotate, and there are no foreign bodies in the dishwasher.	
		SALE SALT SEL SALZ SAL		ON-OFF

8.3 First use each day (tank and boiler empty)

Indicator lights showing: ○ off; ⊙ green; ⊖ orange; ☼ flashing.

Display shows	Actions and what happens
	<p>With the door closed: Press ⊙ and hold it down, with word FILL appears.</p>
	<p>the dishwasher fills the tank after the water in the boiler has heated up; light L2 shows orange and the boiler heating element symbol ☼ appears on the display.</p>
	<p>Wait for P1 to appear and LED L1 to change from red to green; the tank heating element light comes on until the set temperature is reached. The duration of this stage may vary depending on the mains water temperature and on the single-phase connection. Press the ⊙ button quickly to display the tank (left) and boiler (right) temperatures for a short time.</p>
	<p>Load the dishes</p>

	<p>Select the program required by pressing P.</p>
	<p>Confirm the program start by pressing L2 and holding it down for 1 second (light L2 changes from green to orange).</p>
	<p>Cycle in progress, the progress of the cycle is displayed by vertical bars which illuminate in sequence. If the door is opened "CLOSE" flashes and the program stops.</p> <p>Close the door again and confirm the program start by pressing L2 and holding it down for 1 second (light L2 changes from green to orange).</p>
	<p>At the end of the program "End" flashes</p>
	<p>Unload the dishes</p>
<p>When the door is closed again, the system offers the last program run.</p>	

8.4 Changing the Program

	<p>With the door closed, to change to a fresh program instead of repeating the last one, press the P button. The programs available are displayed.</p>
	<p>If a program has already started, press L2 and hold it down to interrupt it.</p>

	<p>change the program by pressing </p>
	<p>Confirm the program start by pressing and holding it down for 1 second (light L2 changes back to orange).</p>

N.B.:

During heating of the water in the boiler and tank with the cycle running, the tank heating element and boiler heating element symbols may appear on the display.

Filter presence sensor (on some models only)

The filter is fitted with a sensor which checks that it is properly fitted; if it is not in the correct position, the word “**FiLter**” appears on the display.

9 CHOOSING THE PROGRAM

PROGRAM	TYPE OF DIRT	DURATION (*)
P1	Glasses	Short, about 1' 30"; 1' with glassware function active.
P2	Glasses, cups and plates with light dirt	Average, about 2' 30"; 2' with glassware function active.
P3	Very dirty dishes and cutlery	Long, about 4'; 5'30" with sani function active.

(*) The cycle duration stated above refers to three-phase appliances supplied with hot water at >50°C <60°C. If the appliance is supplied with cold water, the cycle duration might increase depending on the intake water temperature, since the dishwasher is fitted with the HTR system, which requires set temperature and pressure for rinsing.

10 SUPPLEMENTARY FUNCTIONS

Indicator lights showing: ○ off; ⊙ green; ⊖ orange; ⚡ flashing.

To select a supplementary function, when the program required is shown on the display (P1, P2, P3 or P4) press the button. Only **one supplementary function** can be selected for each program.

10.1 Selecting the "Crys" glassware" function (available in P1-P2)

Reduces the program's rinsing temperature and duration

After selecting the "Crys" function, perform a cycle with the appliance empty to stabilise the boiler temperature

	<p>Press and hold it down to select the glassware function then press to confirm the program start.</p>
--	---

10.2 Selecting the "extra rinse" function (available in P1-P2-P3-P4)

Extends the duration of the rinse

	<p>Press and hold it down to select the extra rinse function then press to confirm the program start.</p>
--	---

During performance of cycles with Extra Rinse, the cycle duration increases by about 30" because of the increased duration of the rinsing phase and the time consequently required to restore the level and temperature in the boiler. If the Termostop is OFF and the dishwasher is connected to cold water, this function will be less effective

10.3 Selecting the “sanitisation” function (only available in P3)

Increases the program’s washing and rinsing temperatures and duration

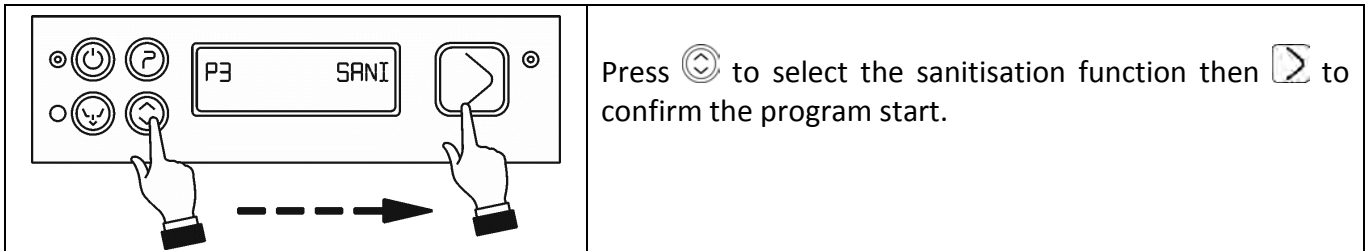

N.B.:

- the supplementary function remains selected until the program is changed or the dishwasher is switched off by pressing the button.
- During execution of the selected program, the display alternates between showing the supplementary function and the duration.

LOADING THE DISHES

Plates

The basket is able to take **8** plates. Remove solid residues (bones, fruit peel, stones, etc.) and first soak plates with dried residues of cheese, egg, etc. in water.

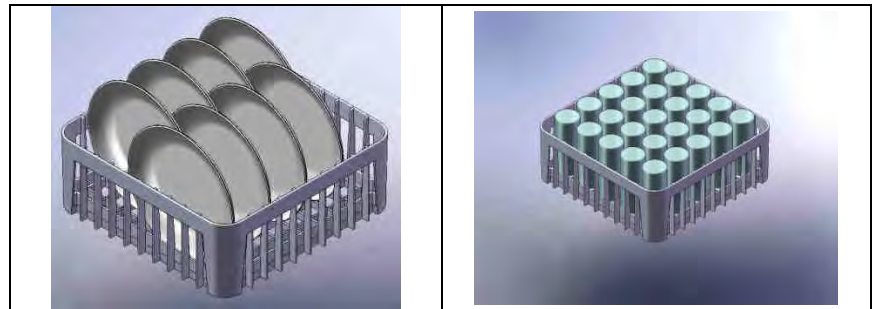

Glasses

Load glasses upside down.

Cutlery

Use the basket(s) provided. Load cutlery loose, preferably with the handle at the bottom, taking care not to injure yourself with fork prongs or knife blades.

TOTAL PUMP-OUT AT THE END OF THE DAY

The dishwasher is able to perform an automatic cleaning cycle at the end of the day.

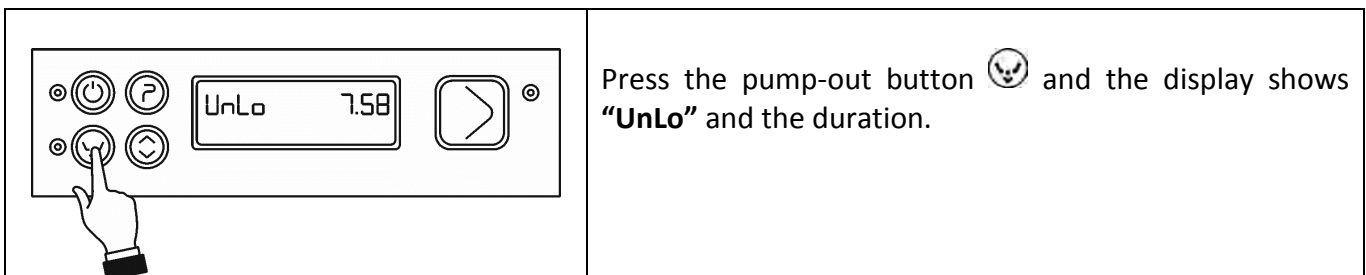

	<p>Confirm by pressing ; light L2 turns orange.</p>
	<p>When pump-out is complete the appliance switches to "OFF" status.</p>

After a total pump-out the filters should be cleaned as described above.



Never switch the dishwasher off with water in the tank; always pump out first.

**TOTAL PUMP-OUT AT THE END OF THE DAY + RESIN REGENERATION
(for models with water softener)**

From time to time, on models with water softener, before the total pump-out at the end of the day the user will automatically be reminded to carry out the resin regeneration cycle, required after a number of washes which depends on the hardness of the water (about 30 for average setting H03). In this case the sequence will be as follows:

	<p>Press the pump-out button ; "rEgE" and the duration appear on the display.</p>
	<p>Confirm by pressing ; light L2 turns orange.</p>
	<p>When pump-out is complete the appliance switches to "OFF" status.</p>

Topping up with regenerating salt (for models with water softener)

Salt must be added when the "no salt" light () appears on the display.

Top up with salt **when there is no water in the tank** to prevent washing water from getting into the water softener device.

Caution: use only salt of the specific type, do not use cooking salt.

The salt tank has a capacity of about **1 kg of coarse-grained salt** .

The salt tank is in the bottom of the appliance's tank. After removing the basket, undo the cap and pour the salt in using the funnel supplied. Remove any salt residues around the opening before screwing the cap back on.

11 MAINTENANCE AND CLEANING

Although no particular scheduled maintenance is required, users are advised to have the dishwasher checked by a specialist technician twice a year.

N.B. the manufacturer accepts no liability for wilful damage or damage deriving from carelessness, neglect, failure to comply with instructions, regulations and standards or incorrect connections.

11.1 Daily cleaning

The dishwasher has **IPX4** protection, but the use of direct water jets for cleaning is **forbidden**.

Cleaning the filter during the day

In case of particularly heavy-duty working conditions, the filter should be cleaned every 30-40 cycles, keeping the machine in operating conditions; to do this, carry out the “partial tank pump-out” routine (program “P0”).

	<p>Press the P button, and hold it down, until “P0” and the duration of 1' appear on the display.</p>
	<p>Confirm by pressing ; light L2 turns orange.</p>
	<p>At the end of the pump-out the word “End” flashes on the display. The display returns to showing “P1”. Clean the filter; the dishwasher automatically fills the tank when the door is closed.</p>

Remove the filters (simply lift them out as shown here), taking care that no large residues fall into the sump underneath. Clean them to remove residues and rinse with plenty of water, then put them correctly back in place; do not use sharp or pointed tools.

Clean away any limescale deposits to prevent excessive build-ups;

- If possible, leave the door ajar when not in use;
- Clean surfaces thoroughly and often with a damp cloth; use neutral, non-abrasive detergents which do not use chlorine compounds, which corrode and damage stainless steel.



Do not use the products mentioned above even when cleaning the floor underneath or in the vicinity of the dishwasher,

to ensure that fumes or drops cannot damage the steel surfaces.

IMPORTANT:The dishwasher automatically performs program “P0” at the start of the day if **water has been left in the tank** and has dropped below the temperature of 40°C

11.2 Routine inspection of the spray arms

Remove the washing and rinsing (top and bottom) spray arms by unscrewing the central screw; remove the rinsing spray arms 3 and remove the screws 2 as shown. **Do not unscrew the nozzles.** Clean the holes and nozzles under a jet of clean running water; **do not use tools which might cause damage.** Reassemble the spray arms with care.

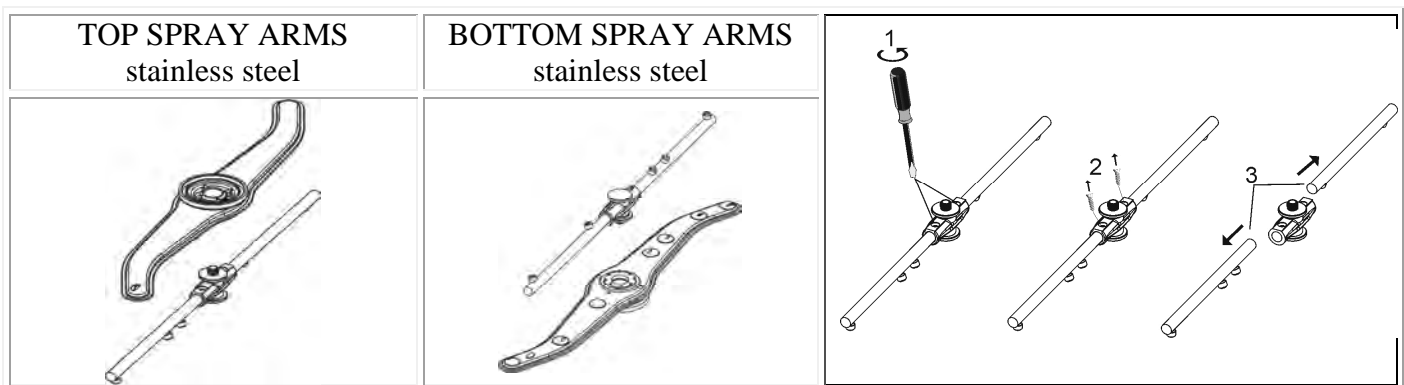

Clean the outside of the appliance with a damp cloth and neutral soap, rinsing and drying thoroughly.

11.3 Lengthy periods out of use

If the dishwasher is to be out of use for a fairly long period of time, **the detergent and rinse aid dispenser devices must be emptied to prevent crystallisation and damage to the pumps:** remove the intake hoses from the detergent and rinse aid containers and place them in a container of clean water, then perform a few wash cycles followed by a complete pump-out.

Finally, turn off the master switch, close the water intake valve and leave the door ajar until the interior is completely dry. The detergent and rinse aid intake hoses must be put back into the containers when the dishwasher is returned to service, **taking care not to swap them over** (red hose = detergent, blue hose = rinse aid).

12 TROUBLESHOOTING

If the system fails to pump out because the drain pump is fouled (as a result of incorrect filter positioning), proceed as follows:

Bale out the dishwasher with a basin and disconnect it from the electrical mains.

Unscrew the screw **A**, release the tang **B** and lift it.

Check that the impeller of the drain pump underneath the cover turns freely, and is free from dirt, limescale residues, or pieces of glass. Never use tools, screwdrivers, scissors, etc.

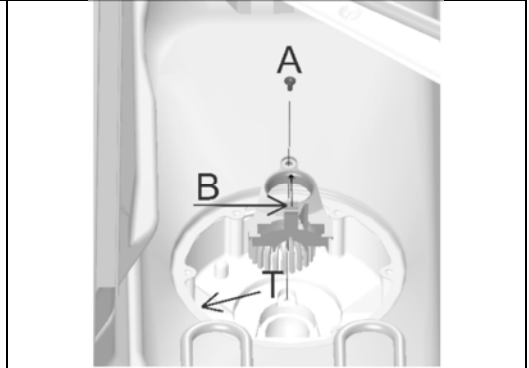

PROBLEM	POSSIBLE CAUSE	POSSIBLE REMEDY
LIGHT S1 DOES NOT COME ON	Mains power failure	Check electrical mains connection.
WASHING PROGRAM DOES NOT START	The dishwasher has not yet finished filling.	Wait for the word FILL to go out.
	The word CLOSE remains on the display	If the word CLOSE remains on the display even with the door closed, call the after-sales service.
POOR WASHING RESULTS	Spray arm washing holes blocked by dirt or limescale	Remove spray arms and clean them (11.2 Routine inspection)
	Filter fouled	See "Cleaning the filter during the day"
	Too little or unsuitable detergent or rinse aid	Check type and quantity of detergent.
	No or not enough detergent or rinse aid being supplied: detergent or rinse aid not being taken from the relative container.	Pipe inside detergent and/or rinse aid peristaltic pump worn or broke, have it replaced by the After-Sales Service.
	Plates/glasses badly arranged	Arrange plates/glasses correctly.
	Low washing temperature	Check temperature shown on the display, call the after-sales service if less than 50°C
	Inappropriate cycle set	Increase washing duration, especially if dishes are very dirty or dirt has dried on.
	Spray arm nozzles fouled	- Check that nozzles are clean, and

	Limescale in boiler	ensure that the softener is working properly (if installed). - Check that the filter of the hose inserted in the rinse aid tank is not fouled.
INADEQUATE RINSING	Rinse aid unsuitable or not being delivered correctly. Rinsing temperature too low	Check container of rinse aid and whether it is suitable for the type of mains water. Check boiler temperature setting Restore T Stop ON and/or connect the appliance to a hot water supply. If the problem persists, contact the after-sales service.
DISHES NOT PROPERLY DRIED	Rinse aid unsuitable or not being delivered correctly. Water hardness above 12°f or large amounts of dissolved salts	Check container of rinse aid and whether it is suitable for the type of mains water. If the problem persists, contact the after-sales service.
STAINS ON GLASSES AND CUTLERY	Drain hose incorrectly positioned or partially obstructed.	Check that the dishwasher drain hose and rain are unobstructed and the drain is not too high up; see connection diagram.
WATER IN TANK AFTER PUMP-OUT	Drain hose incorrectly positioned or partially obstructed.	Check that the dishwasher hose and drain are unobstructed and the drain is not too high up; see connection diagram.

13 MALFUNCTIONS SHOWN ON THE DISPLAY (FOR THE USER)

The dishwasher is able to identify a number of malfunctions and show them on the display. If the problem persists after the dishwasher has been switched off and back on, proceed as described below:

(TO ALLOW THE AFTER-SALES SERVICE TO TAKE THE APPROPRIATE ACTION, ALWAYS MAKE A NOTE OF THE ERROR INDICATED)

Err04	Tank temperature probe malfunction	Contact the After-Sales Service
Err05	Tank water filling malfunction	Check that the water intake tap is on and the dynamic pressure in intake system, inspect water intake filter and clean if necessary. If the problem persists, contact the After-Sales Service.
Err06	Water pump-out malfunction (dishwasher is left full of water)	Inspect the filters for dirt and check that the drain hose is not blocked, bent or crushed. Check that the drain pump is not blocked by dirt; proceed as described in point "11.2 Routine inspection". If the problem persists, contact the After-Sales Service.
Err09	Tank water level too high	Contact the After-Sales Service.
Err23	Boiler heating malfunction (does not heat up)	Contact the After-Sales Service.
Err24	Boiler temperature probe malfunction	Contact the After-Sales Service.
Err25	Boiler water filling malfunction	Check that the water intake tap is on and the dynamic pressure in intake system, inspect water intake filter and clean if necessary. If the problem persists, contact the After-Sales Service.
Err26	Boiler emptying malfunction	Check that the rinsing spray arm nozzles are not fouled If the problem persists, contact the After-Sales Service.
Err27	Boiler emptying malfunction – with tank full	Contact the After-Sales Service.
Err28	Boiler heating malfunction (overheating)	Contact the After-Sales Service.

INFORMATION AND AFTER-SALES SERVICE FOR SMEG PRODUCTS

COMMERCIAL DISHWASHERS

Our Sales Department staff will be able to provide you with information about prices and special offers.

Our After-Sales Department will be able to provide you with guidance about keeping your appliance functioning correctly and put you in touch with your nearest authorised Service Centre.



* Maximum cost 14,26 cent./min. including VAT with no charge on answer from landline.
 Maximum cost 48 cent./min. including VAT with maximum charge on answer of 15.49 cents including VAT from cell phone.

For further details of costs of calls from cell phones contact your operator.

Our whole product offering can be viewed at:

www.smeg-ristorazione.com

International customers, please contact your local SMEG distributor.

Smeg S.p.A.

Via Leonardo da Vinci, 4 - 42016 Guastalla (Reggio Emilia)

Tel. +39 0522 8211 - Fax + 39 0522 821453

email ristorazione@smeg.it

19.390.2672.02	25/03/2014
Manual Ed.	Date